

AERIS WINDOWS



— AERIS™ —

WINDOWS

THE BEAUTY OF WOOD INSIDE

THE PROFESSIONAL WAY

ProVia® has developed a competitive position by catering to a niche market that demands a high degree of customization coupled with superior quality. You will find attention to detail is what our customers have come to appreciate and expect from us. We're building your windows and our company to last a lifetime...that's **The Professional Way**.

**MULTI
TIME**

Partner of the
Year Award



90%+

of Windows and Doors
are ENERGY STAR®
Certified

**remodeling
BRAND
LEADER**

#1 Quality
Rating
Vinyl
Windows

DOORS • WINDOWS • SIDING • STONE



6 Facilities in the United States

900+

Associates Nationwide

Our Mission:

— TO SERVE BY CARING FOR —
DETAILS
IN WAYS OTHERS WON'T

Doing Business Since

1977

19

Core Values

200+

Metric Tons of CO²
Saved Annually

1,900+

Tons of metals, paper, glass and vinyl
recycled annually at ProVia facilities

Visit provia.com to explore all of our products and options or
download the app.





INDUSTRY ASSOCIATION

ProVia is a proud member of the Window & Door Manufacturers Association, which promotes the standards of excellence in the residential window and door industry, and advances these standards among industry businesses with resources designed to provide greater value for their customers.



ACCREDITATION AND TESTING

ProVia's products are voluntarily third party tested and rated in several energy performance categories through the National Fenestration Rating Council and meet or exceed standards governed by the American Architectural Manufacturers Association.



ENERGY STAR®

ProVia manufactures energy efficient products and exercises environmental stewardship by recycling, reducing pollution emissions and much more. In fact, our company has received repeated awards from the Environmental Protection Agency such as Partner of the Year - Sustained Excellence for outstanding efforts in energy savings.

TABLE OF CONTENTS

Why Choose Wood-Clad Vinyl.....	2
Standard Features	3
Insulation and Weatherstripping.....	5
Screen Options	6
Window Types.....	8
Color Options	10
Painted Exterior	13
Hardware Finishes	14
Glass Packages	18
Privacy and Tint Glass Options.....	19
Internal and External Grids	20
Internal Blinds	22
Decorative Glass.....	24
Inspirations™ Art Glass	27
MasterFit™ Trim	29
ProVia App & Visualizer.....	32

WHY CHOOSE WOOD-CLAD VINYL

YOUR VERSATILE WINDOW SOLUTION



Add warmth to the interior of your home with wood. Aeris windows are wood-clad, allowing you to choose between several factory-finished paint and stain colors to complement your homes' unique style.

The exterior of Aeris Windows are constructed of a uniquely formulated, proprietary European vinyl compound proven to perform better than alternative building materials. Vinyl ensures long-lasting color-retention and low maintenance, plus the added confidence of a warranty against rotting, cracking, pitting, corroding and peeling. The vinyl is resistant to rot, insect and microbial damage, never requires painting and is easy to clean.

Low Maintenance

Vinyl windows are the low-maintenance choice for residential use.

Superior Weatherability

The vinyl compound is uniquely formulated to withstand the harsh effects of weather, UV light and southern exposure.

Color Retention

Pharmaceutical-grade compounding and blending systems provide consistency, so you can rely on superior color and weatherability.

Designed to Perform

Industry partnerships and on-going research into new technologies ensure the vinyl compound exceeds industry standards, outperforms the competition, and works together to offer best-in-class technology.

Choosing both wood and vinyl for your window is a win-win – you get the beauty of wood inside, plus low-maintenance vinyl outside.

STANDARD FEATURES

WHAT TO EXPECT WITH YOUR AERIS WINDOW

Aeris windows can be completely customized to fit your exact style. Everything from the size of the window, the interior and exterior colors, hardware finishes, glass packages and trim options can be chosen by you.

Design the windows for each room in your house differently, or if you prefer a simple, seamless look, your windows can all be the same. The design options available to you are virtually endless. The features below are standard on all Aeris window styles.

Pre-Finished Real Oak, Cherry or Maple Wood
Applied to Sash and Frame Interior

3¼" Frame Depth with Welded Frame and
Sash Construction

1" ComforTech™ DLA-UV Insulated Glass Unit

Neopor® Insulation

Barrier-Fin and Bulb Weatherstripping

Extruded Aluminum Full Screen with BetterVue®
Fiberglass Mesh

Accessory Grooves for more Interior and
Exterior Trim Options



LIFETIME
— LIMITED WARRANTY —



Shown: Aeris Casement Windows with Painted Interior

INSULATION

Neopor®

Neopor is a graphite polystyrene rigid foam insulation that gives maximum efficiency and sustainability in building products. It is comprised of many small pockets of air within a polymer matrix containing graphite. The graphite reflects radiant heat energy like a mirror, increasing the material's resistance to the flow of heat, or R-value. Most polymer-based foams exhibit a greater ability to slow the movement of heat as the temperature decreases; however, Neopor is unique because it increases R-Value as the temperature outside drops.



The vinyl profiles used in an Aeri™ window are designed with premium wall cavities providing the highest levels of efficiency. This strong and rigid vinyl extrusion keeps you comfortable in your home without the need for insulation.

To provide further comfort, ProVia® uses Neopor insulation in certain cavities for even greater performance. Therefore, you can rest assured both the window frame and sash, along with the Neopor insulation are effectively regulating the temperature inside your home.

WEATHERSTRIPPING

Weatherstripping is a very important part of preventing air from coming into your home. ProVia's windows have weatherstripping on the frame and sash, ensuring you get a good seal at the important locations where air could pass through.

Bulb Seal



Bulb seals are seamless closed-cell compression seals that prevent water from penetrating the foam cell structure. Its extruded skin provides a unique UV resistant barrier with design features that enhance the weatherstrip's sealing performance.

Barrier-Fin



Seal woven and extruded pile weatherstripping with fin provides a very effective barrier against air, water, dust and noise, sealing against even and uneven surfaces with resistance to abrasion.

TEST SPECIFICATIONS

Aeris Double Hung 40" x 63"

Test	Test Specification	Results
Air	ASTM E 283	0.15 cfm/ft ² @ 25 mph
Water	ASTM E 547	9.19 psf
Structural	AAMA/WDMA/CSA 101/1.5.2/A440-8 and 11	R-DP50 155 mph

Test data is a result of sizes shown, configurations and lab conditions of a certified independent third party laboratory.

Please reference the Window & Patio Door Technical Specifications Brochure for testing data on other window types.

YOUR SCREEN MESH OPTIONS

STANDARD

BetterVue® Fiberglass

Your Endure™ window will come standard with an extruded aluminum frame with BetterVue fiberglass mesh, which can be easily removed for regular cleaning and maintenance.

BetterVue screen mesh is very durable and flame retardant, providing an enhanced view, increased insect protection and improved airflow.

Now featuring Phifer's® Water Shed Technology™, which preserves optical clarity by shedding water and resisting dirt and grime.

The Water Shed Technology features a hydrophobic coating that will not wash off, which allows the screen to shed water and debris from a rainstorm or garden hose. This means your screen virtually eliminates window panning, a process by which the water fills the open squares in the screen.



OTHER OPTIONS

FlexScreen®

Nearly indestructible. Barely visible.
Available with BetterVue or Heavy Duty Fiberglass Mesh.

SIMPLE DESIGN

PVC coated spring steel frame with no attachment hardware.

EFFORTLESS INSTALLATION

Simply hold the screen in your hands, bend the sides in, and fit FlexScreen into your screen pocket.

DAMAGE RESISTANT

No more bent aluminum frames, scratched paint and broken hardware.

BEAUTIFULLY INVISIBLE

FlexScreen easily hides in the window screen pocket, drastically improving sight lines.

Lifetime Limited Warranty



SeeVue® Stainless Steel Screen

Much stronger than the standard insect screen, this stainless steel screen is excellent for window and patio door applications. It is black coated for improved visibility and allows superior airflow.

If you're looking for a stronger alternative to the BetterVue screen, upgrade to a SeeVue. This screen mesh is available in an extruded aluminum frame.

Also available: Aluminum and Heavy Duty Fiberglass Screen Mesh

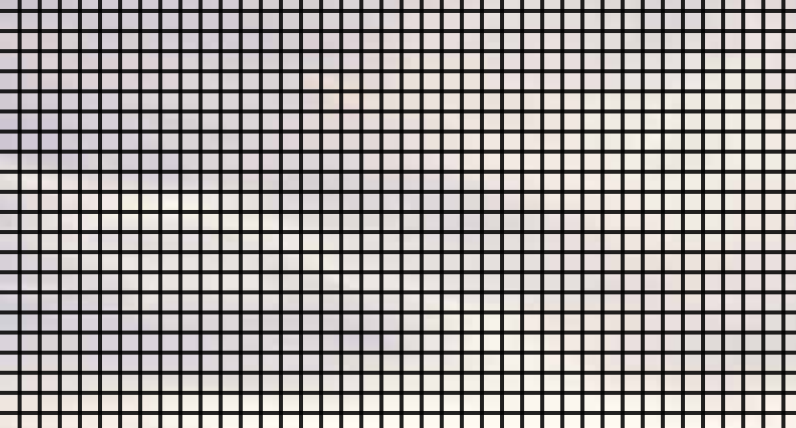

Industry Standard Insect Screen

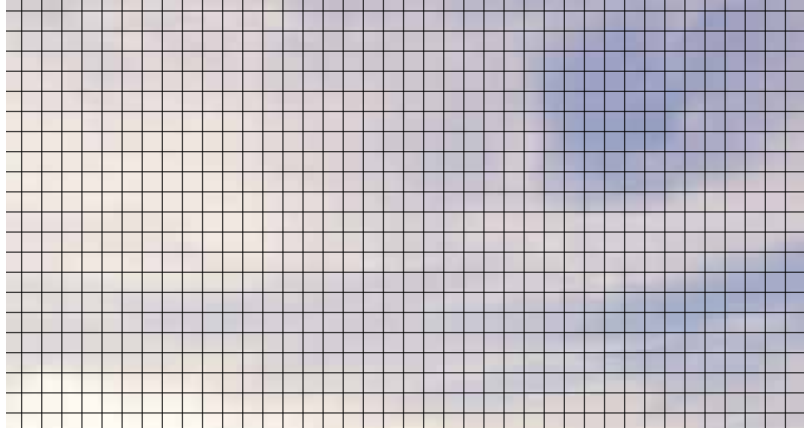

BetterVue® Screen



CHOOSE YOUR WINDOW TYPE

DOUBLE HUNG



Double hung windows are ideal in every room of the house since they are easy to open and clean. Both sash tilt inward, while the screen stays in place. Put two or more double hung windows in a row to create an aesthetically appealing look.

Features

- Compound Tension™ Balance System
- Interior Glazing
- Cove Sash Profile
- Dual Weatherstripping
- Two DualTech™ Locks with Integrated Tilt Latches
- Wood Lift at Lock Rail

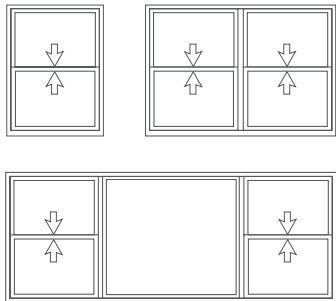

SLIDER



Slider windows are another classic found in many homes. These windows work well above the kitchen sink or in any room where ventilation is important. Slider windows work great by themselves or paired with picture windows.

Features

- Brass Rollers
- Interior Glazing
- Cove Sash Profile
- Dual Weatherstripping
- Two DualTech Sweep Locks
- Extruded Aluminum Full Screen
- 3 Lite Sliders come standard with Anchor Stops

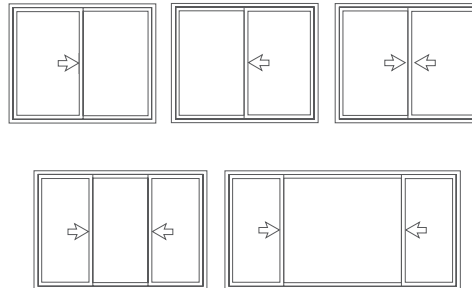

PICTURE



Picture windows are perfect for any room with a view. They help capture the beauty that surrounds your home, while complementing other windows. Pair several picture windows together to bring in the beauty of the outdoors.

Features

- Fully Welded Construction
- Direct Glazed Frame

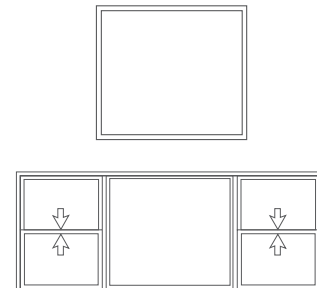

CASEMENT & AWNING



Casement and awning windows add style and flair to your home, allowing the perfect amount of ventilation desired. Group casement and awning styles together to create a beautiful wall of operational windows.

Features

- Interior Glazing
- Multi-Point Locking Hardware
- Fold-Away Handle
- Square Sash Profile
- Washability Hinge (Casement)
- Optional Simulated Double Hung Meeting Rail (Casement)
- Quick-Release Dual Arm Operator (Awning)

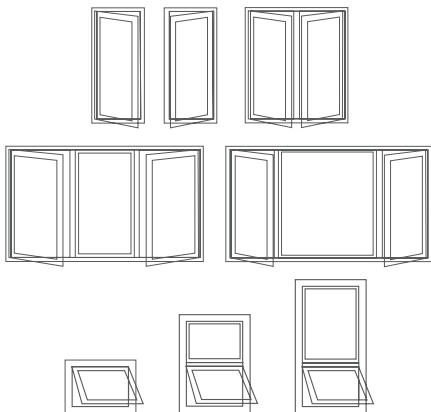

BAY & BOW



Bay and Bow windows look amazing in a living room or master suite, giving you the versatility to choose a combination of picture, double hung or casement windows. The seat on a Bay or Bow window is a great place to sit and read or just enjoy the view.

Features

- Bay:** 3-Lite Unit with 2 Operable Windows with Screens
- Bow:** 3, 4, 5 or 6-Lite Units with 2 Operable Windows with Screens

Roof Kits Available in wood, painted aluminum and copper.



Bay Window - Hip Style Roof



Bow Window - Hip Style Roof

ARCHITECTURAL SHAPES



Architectural shapes will complement your home's unique style, while allowing more natural light to brighten up your space. Shaped windows look great above other styles of windows or they can easily accent a patio door.

Features

- Fully Welded Frame
- Direct Set Glass
- Wide Range of Shapes to Choose from

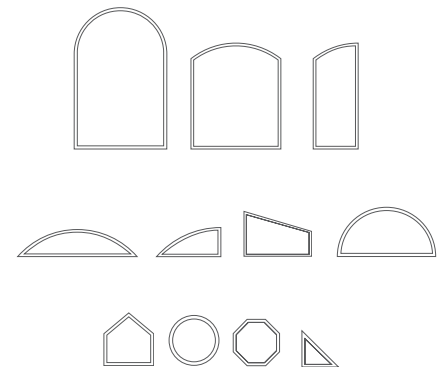

CHOOSE YOUR COLORS

Aeris™ windows feature factory finished real wood interiors. Remember, each room in your house is unique, so your windows should be too. Due to the nature of hand-applied stain on wood, colors and grain patterns may vary slightly.

Exterior Vinyl Colors



*Classic Bronze is a laminated option.

TUFTEX Smooth Cladding Colors

Aluminum trim coil with mar-resistant smooth finish



Interior Stain Finishes

Oak



Cherry



Maple



Interior Paint Finishes

Maple

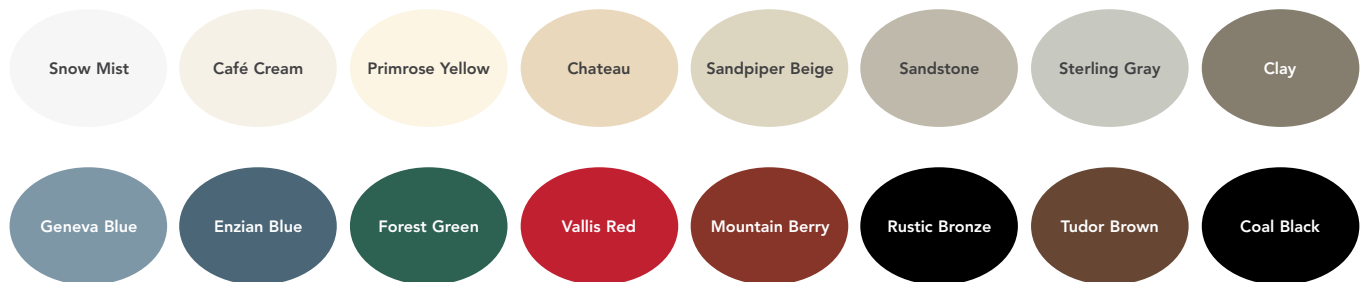

Please refer to our color selector for accurate color representation.

Jamb pocket color may be different than the interior paint or stain color. Please see the chart on pg. 14 for more details.

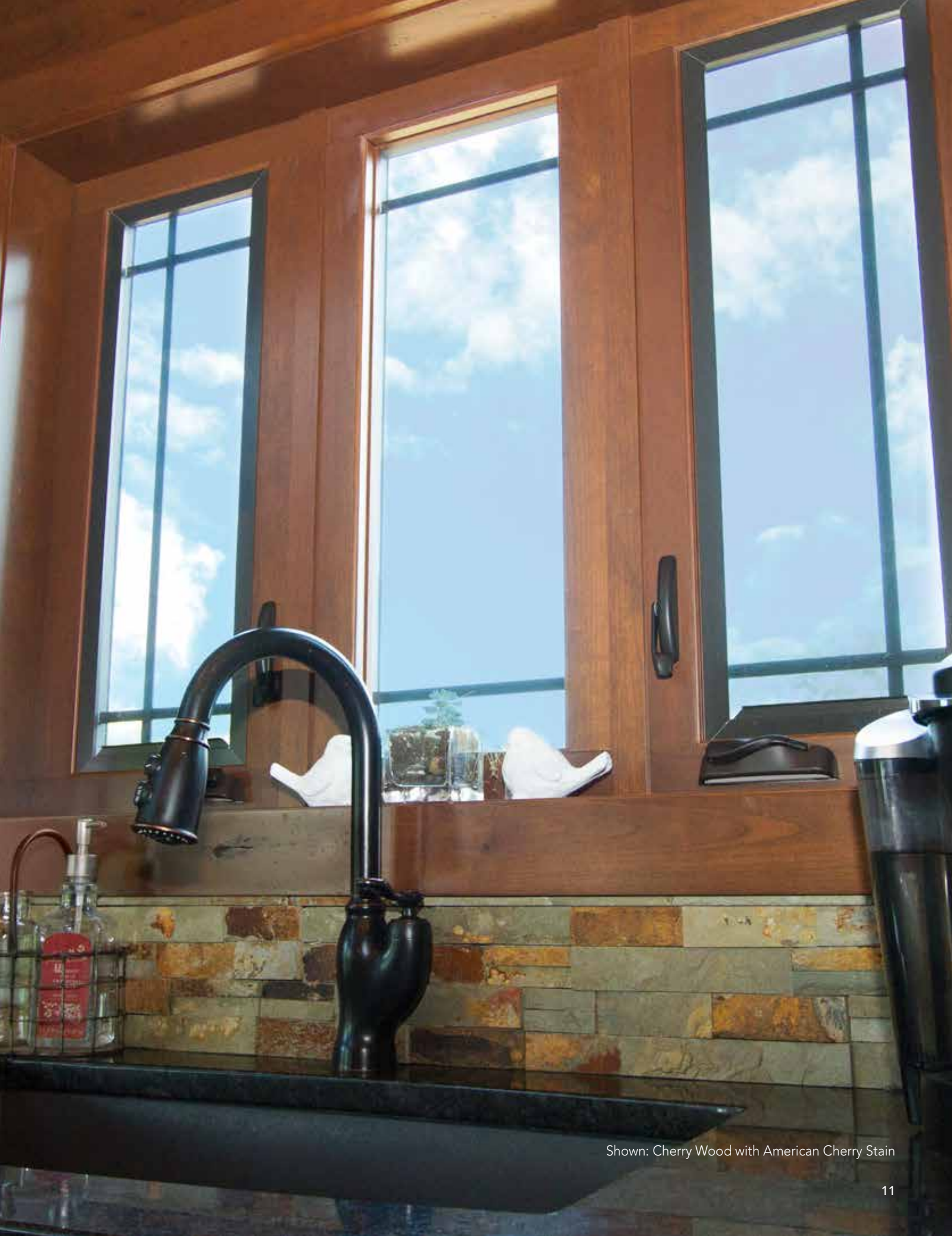

Shown: Cherry Wood with American Cherry Stain



Shown: Classic Bronze Painted Exterior

UPGRADE TO A PAINTED EXTERIOR

Complement the exterior of your home with painted windows to give your house a distinctive look. Choose from one of ProVia's standard paint colors or use your creative imagination and custom-match any color of your choice.

The factory-applied paint finish maintains long-lasting color due to its exceptional UV and heat reflective properties. Choosing to paint the exterior of your windows means no worry of peeling, flaking or blistering.

15-year warranty on paint finish

Standard with FlexScreen (see page 6)

Allow for an additional lead time



View of jamb pocket from exterior

Exterior Paint Finish Options



Please refer to our color selector for accurate color representation.



Custom-Matched Paint Colors

How to Order Custom Painted Windows

1. Visit a Sherwin Williams paint store and select a paint color of your choice.
2. Specify the selected color name and paint number from the paint color swatch at the time of order.

OR

1. Provide your dealer with three 3" x 3" samples of the selected color for ProVia® to match.*

*Homeowner sign off is required on all custom color matches. Color match fee applies.

SELECT YOUR HARDWARE FINISH

Double Hung and Slider Windows

Standard Finishes



White

Beige

Sandstone

Optional Decorative Finishes with DualTech™ Integrated Tilt Latches



Bright Brass

Antique Brass

Satin Nickel

Flat Bronze

Casement Hardware

Standard Finishes



White

Beige

Sandstone

Optional Decorative Finishes



Bright Brass

Antique Brass

Satin Nickel

Flat Bronze

Jamb Pocket & Hardware Finish Chart

Exterior Window Color	Interior Window Color	Interior Jamb Pocket Color	Suggested Hardware Finish
White	White	White	White
White	All Stains & Paint Colors (except White)	Sandstone	Sandstone
Beige	All Stains & Paint Colors	Beige	Beige
Sandstone	All Stains & Paint Colors	Sandstone	Sandstone or Decorative Finish
Classic Bronze	All Stains & Paint Colors	Sandstone	Sandstone or Decorative Finish
Painted Finish	All Stains & Paint Colors	Homeowner Chooses	Homeowner Chooses





Shown: Flat Bronze Hardware

THE BEAUTY OF WOOD INSIDE

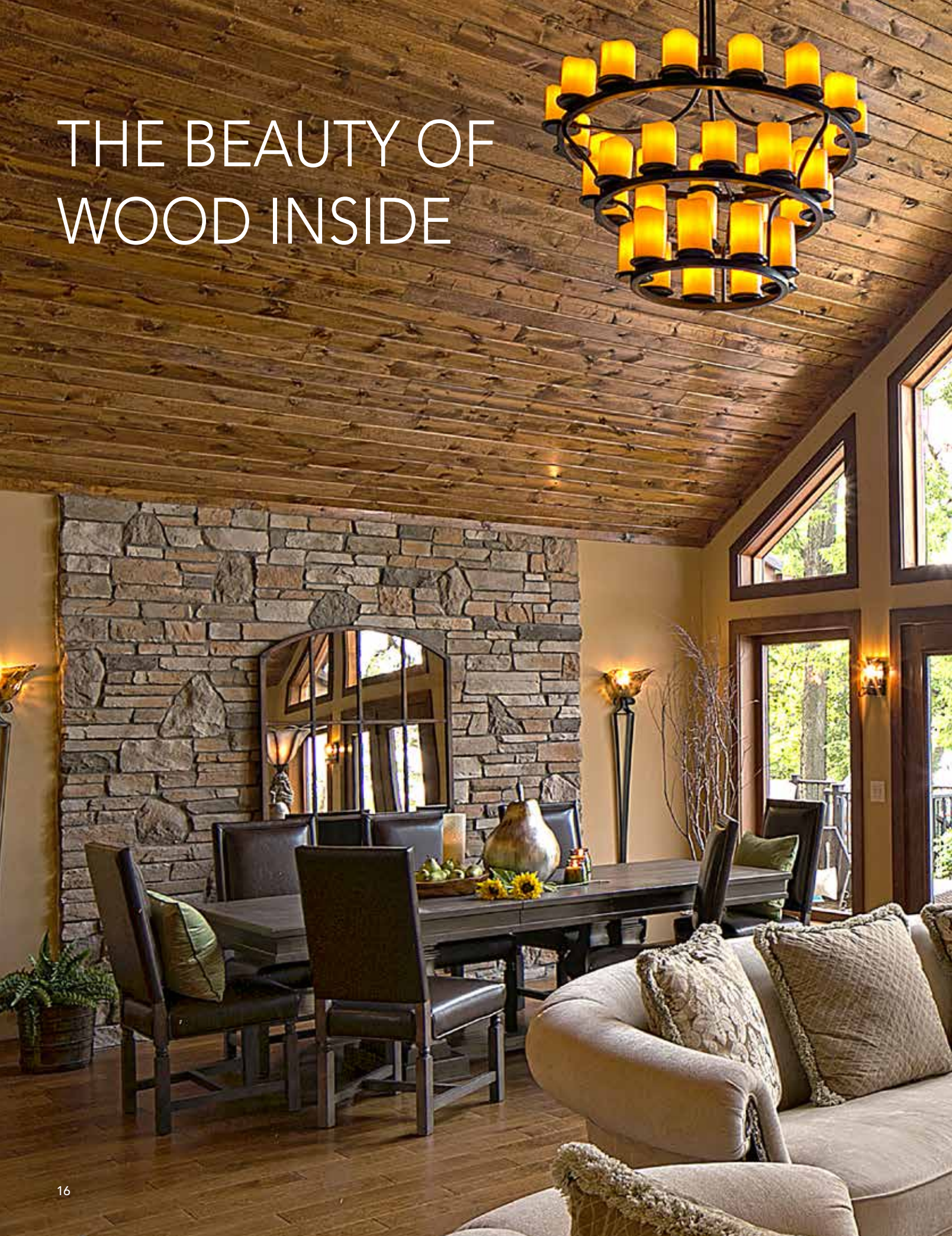



WHICH GLASS PACKAGE IS RIGHT FOR YOU?

FEATURING COMFORTECH™ WARM EDGE GLAZING SYSTEM

Most of your new window is glass. That's why we use the ComforTech Warm Edge Glazing System featuring Super Spacer® on all Aeris™ windows. This gives you reduced heat loss, warmer glass temperature and reduced interior condensation. All ComforTech products have passed stringent testing and are IG Certified to ensure seals are durable and will not leak.



The No-Metal Advantage

Thermal efficiency through no presence of conductive metals is the Super Spacer hallmark.



Mylar 10-Layer Vapor Barrier

The Super Spacer thermoset foam matrix is exceptional. Moisture is kept out, gas is kept in and conductivity is virtually nonexistent.



Lasting Appearance

Our Warm Edge Glazing System stands up to the natural bending and bowing from temperature changes, barometric pressure and wind load.



Enhanced Noise Reduction

The all-foam formula's excellent sound dampening properties reduce outside noise, even in industrial environments.

WHAT'S THE DIFFERENCE?

Krypton Gas

Inert to glass coatings, heat and spacers, krypton gas has the lowest conductivity of any gas used and raises the inner glazing temperature. This gas performs well in small chambers, making it the best choice for our triple-glazed glass packages.

Argon Gas

Chemically inert to UV radiation, argon gas insulates better than air. It is sunlight stable, non-corrosive and non-toxic, making it the best choice for our double-glazed glass packages.

ComforTech™ TLK-UV

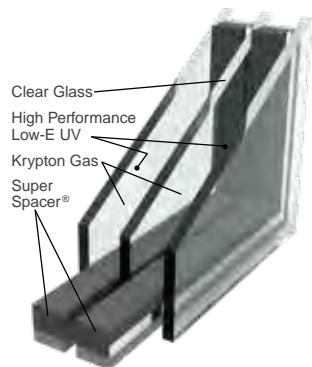

R-Value of 9

ComforTech™ TLA-UV

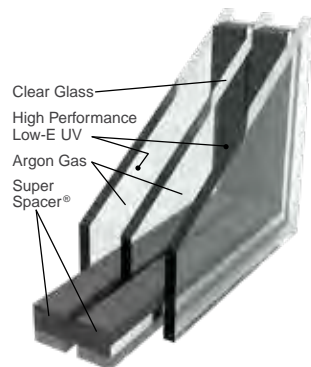

R-Value of 6

ComforTech™ DLA-UV-HC

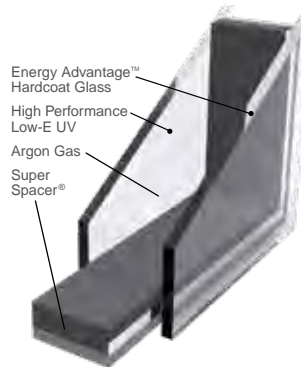

R-Value of 5

ComforTech™ DLA-UV

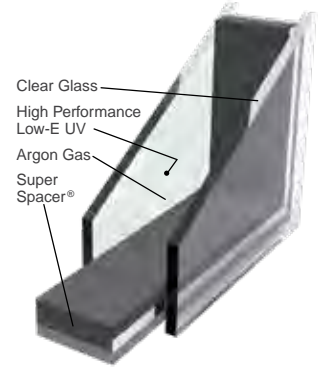

R-Value of 4

ADD EXTRA PRIVACY AND TINT TO YOUR WINDOW

Privacy Options

Choose from five different types of glass if you need light to filter in, yet want to maintain privacy. These glass styles look great in rooms where privacy is important. Regardless of where it is used, privacy glass reduces the likelihood of needing extra window coverings.



CHINCHILLA



TAFFETA



WATERFALL



GLUECHIP



OBSCURE PEBBLE

Actual privacy levels will vary depending on your distance from the glass and also the amount of light in the room in comparison to the light outside your home. For extra privacy, choose two panes of privacy glass, rather than just one.

Tint Options

Our tinted glass can help reduce UV transmittance, solar heat gain and glare. Tinted glass options can give a room a whole new look, providing its own unique set of benefits. Be sure to choose the right one for your home.



Solargray® Gray Tint

- Excellent glare control
- Exceptional protection against interior fabric and color fading
- Ultraviolet light protection



Solarbronze® Bronze Tint

- High visible light transmittance
- Warm glow to interior décors
- Complements brick and stone
- Ultraviolet light protection



Solexia® Green Tint

- Subdues interior brightness
- High visible light transmittance



Azuria® Blue Tint

- Low shading coefficient
- High visible light transmittance
- Solar performance (reduces solar heat gain)

STYLE YOUR WINDOW WITH GRIDS

The style of grids you choose can make a big impact on your home's appearance. Grids look great on the front side of a house or in accent windows throughout the home. You can choose from internal or external grids and several grid patterns including variations of Colonial, Cottage and Prairie styles.



External Grids

Simulated Divided Lites (SDL)

Grids are applied to the glass on both the interior and exterior of the window. If you decide to get painted windows, choosing SDLs as your grid choice allows the SDLs to be painted to match your interior and exterior window color.

Internal Grid Types

If you want grids, but prefer not to clean around them, opt for internal grids so you get the same look and feel, without the hassle.



Contoured

Flat

Pencil
Available in Satin
Nickel, Brass and
Bronze

V-Groove



Triple Glazed Glass

Internal grids with triple glazed glass are placed between two glass panes with the added efficiency of a third pane.

Double Glazed Glass

Internal grids with double glazed glass are placed between two panes of glass.

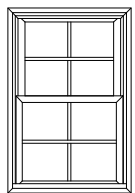

Cottage

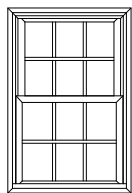

Colonial

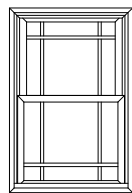

Prairie

Internal and external grids are available in many configurations of Cottage, Colonial and Prairie styles.



Shown: Double Hung Windows with Custom Grids

ADD INTERNAL BLINDS

If cleaning dusty blinds makes you cringe, be sure to add internal blinds to your windows. These blinds are made with sturdy aluminum and are custom-fit to the exact dimensions of each window.

Internal blinds work great in all bedrooms and bathrooms in the house. Blinds can be lifted up to allow maximum light in or they can be tilted to keep some light out and to maintain privacy.



Interior View



Blind operator as viewed from the interior of the home

Complement the interior of your home with one of five colors:



Blinds can be added to Double Hung (top, bottom, or both sash), Casement, Awning, Picture and Slider windows.

Blind slats are 1/2" wide.

Internal Blinds come with a **10-year Limited Warranty**.

Allow for additional lead time on your window order.





Shown: Cream Internal Blinds

CREATE A FOCAL POINT

WITH DECORATIVE GLASS

Want to wow your neighbors and add style to your home? Be sure to order one of the decorative glass options when you place your window order. Each piece of glass is unique, customized to fit any window shape and style. Decorative glass can be ordered in full, simplified and transom pattern options. Add some elegance to your design by choosing a coming color to complement your home.

Enhance your view of the outside world by adding windows with decorative glass to any room in the house - the design options available with this program are virtually endless. The six designs shown below are just a small portion of what is available. See the Decorative Glass brochure for more information.

Esmond



Essence



Symphony



Carrington



Somerset



Gemstone



Decorative glass is available in Double Hung (top and/or bottom sash), Casement, Awning, Slider, Picture and Architectural Shape style windows.

Designs will vary depending on window size. A drawing, showing the pattern based on the exact window size ordered, will be provided for approval. Please see the Decorative Glass brochure for more style options. All decorative glass requires additional lead time.



Shown: Carlisle Glass



Lincoln with Coral Reef Color Palette



Blossoms with Caribbean Color Palette



Harmony with Caribbean Color Palette



Tulips with Vineyard Color Palette

IMAGINE THE POSSIBILITIES

WITH INSPIRATIONS™ ART GLASS

Inspirations Art Glass allows you to do just what the name suggests, let your windows and patio doors reflect the inspiration of your imagination with your choice of design and color.



Explore Design and Color Options

Ask to see our Inspirations Art Glass brochure for available styles and color palettes, visit provia.com or use the ProVia app to create custom color palettes and design your dream window. Inspirations Art Glass is available in Double Hung (top and/or bottom sash), Casement, Awning, Slider, Picture and Architectural Shape style windows.



Color Palettes

The greatest advantage of Inspirations Art Glass is the opportunity you have to add color to your glass. There are a variety of unique color palettes to suit your home's style.

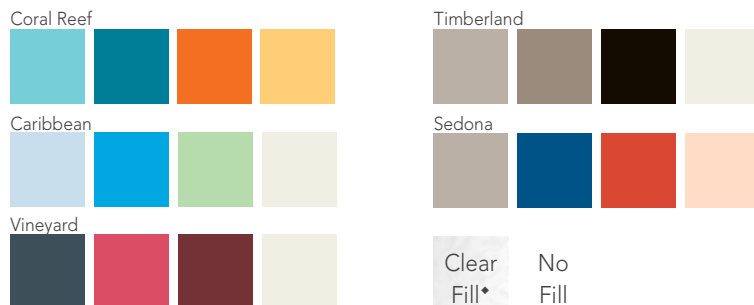

* Increases transparency on textured glass and resembles aged glass

Resin Beads

Available in four color options.



Combine your favorite color palette and bead color with your choice of design to show your personality on your windows.

Note: All Inspirations Art Glass requires additional lead time.



FINISH YOUR WINDOW WITH MASTERFIT™ TRIM

Add the finishing touch to the interior of your windows with the MasterFit trim system, complete with assembled frame extensions that interlock with mortise and tenon casing. Our MasterFit trim system guarantees a precise, custom-fit and long-lasting factory applied finish.

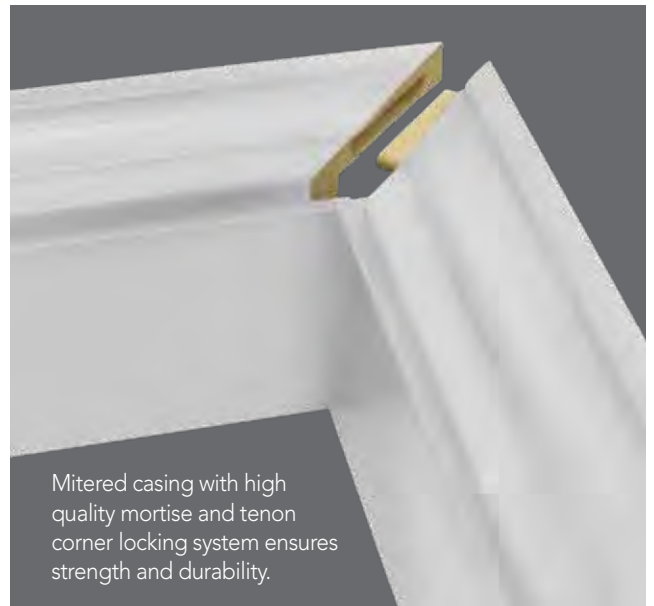

Profile Options



Additional Trim Options



Stain Finishes

Oak



Cherry



Maple



Paint Finishes

Poplar



Please refer to our color selector for accurate color representation.







SHOW US YOUR STYLE AND CONNECT WITH US!

We love seeing how you apply our products to your home. Share photos with us.



CREATE YOUR DREAM HOME

WITH PROVIA'S EXTERIOR HOME DESIGN TOOLS

Find inspiration for the exterior of your home.
Download ProVia's free app for iPad or try the online Visualizer at provia.com/visualizer.



PROVIA VISUALIZER

Use ProVia's Visualizer to change the colors and styles of your home's doors, windows, siding and stone.

Let your imagination run free with this exterior home design tool. Select from a library of existing home styles, choosing one to match yours, or upload a photo of your own home.

In a few easy steps, update your siding color, add manufactured stone, give the windows a fresh look or personalize a new entry door.

Not sure where to start? Apply one of our pre-selected Designer Collections, then further customize the selections to reflect your own personal style.



PROVIA APP

Use the ProVia app to configure doors and windows or select from an extensive collection of vinyl siding and manufactured stone styles.

FEATURES

Door and Window Configurator

Vinyl Siding Profiles, Colors and Accessory Accents

Manufactured Stone Styles, Color Palettes and Grout Options

View Videos, Photo Galleries and Catalogs

Locate a ProVia Dealer





“To serve, by caring for details in ways others won’t.” It’s not just our mission, but a way of letting our light shine every day at ProVia®. We continually strive to put these words into action by providing unmatched quality and service. The P-icon symbolizes each employee’s commitment to devoting the utmost care, pride and quality into each building product we manufacture...it’s The Professional Way.



At ProVia, we manufacture energy efficient products and exercise corporate environmental stewardship by recycling, reducing pollution emissions and much more. In fact, our company has received repeated awards from the Environmental Protection Agency such as Partner of the Year - Sustained Excellence for outstanding efforts in energy savings.



Doors • Windows • Siding • Stone
provia.com

© 2019 ProVia
P-MK-02500-19 5/19

Distributed by:

